



CT45 B Quick guide



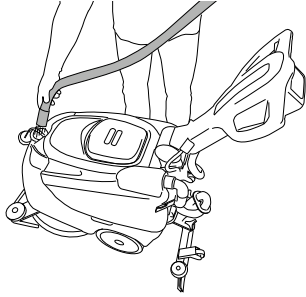

This guide is intended for quick consultation only and does not replace the user and maintenance manual. Before using the machine, read the user and maintenance manual contained in the machine's packaging thoroughly and strictly follow all the instructions.

PREPARATION & OPERATION

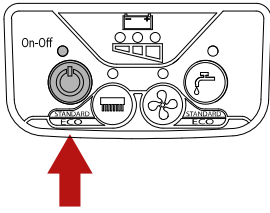
1 

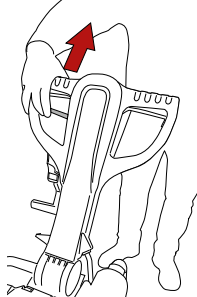
2 

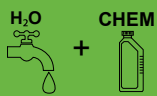
3 

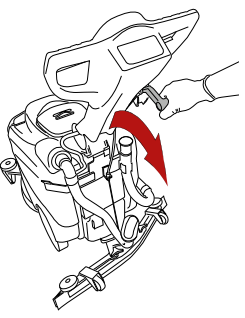

 |  | 

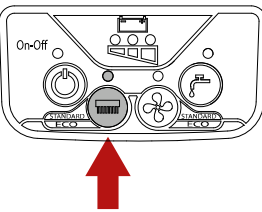
5 

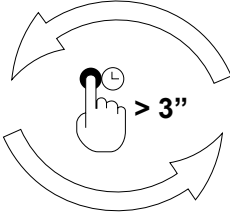
6 

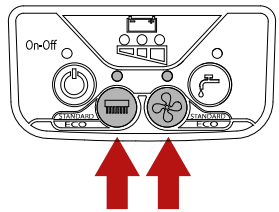





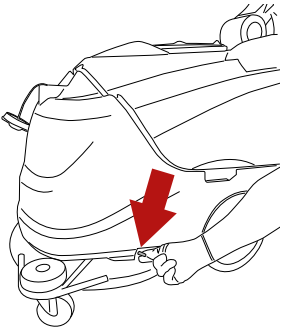

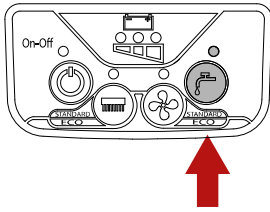
 |  | 

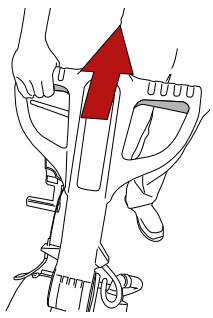
7 



8 

9 

 |  | 

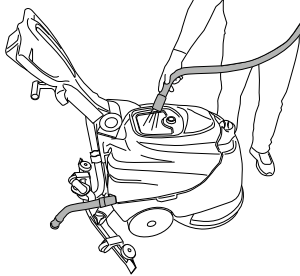
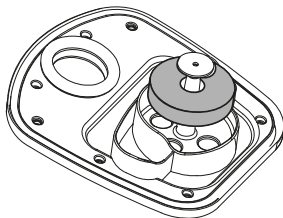
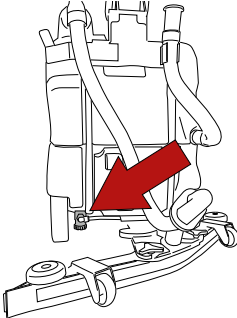
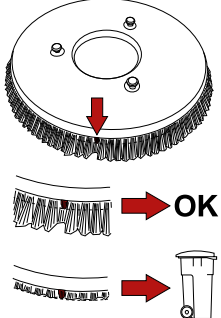
DAILY MAINTENANCE

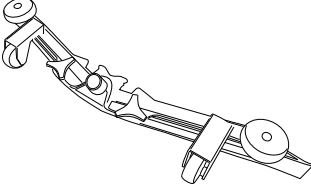
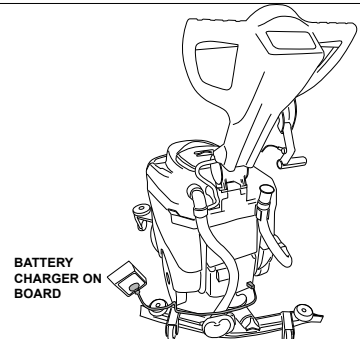
			
<p>Clean the dirty water tank.</p>	<p>Check the dirty water tank float is undamaged and clean and moves freely on the pin.</p>	<p>Check that the detergent outlet filter is clean.</p>	<p>Check that the brush is clean. Replace if necessary.</p>

	 <p>BATTERY CHARGER ON BOARD</p>
<p>Check that the squeegee is clean and the blades are not worn.</p>	

REPLACING THE SQUEEGEE BLADES

Open the clip (Ref. 1).

Remove the two blade retainers (Ref. 2) by pushing them outwards then extracting them.

Remove the blade.

Reuse the same blade by reversing the edge in contact with the floor until all four edges are worn out, or replace with a new blade, fitting it onto the screws on the body of the squeegee.

Reposition the two blade pressing devices by centering the wider part of the slots on the squeegee body fastening pins, then push the blade pressing devices inwards.

Close the hook again.

Replace the squeegee on its support, following the instructions described previously.

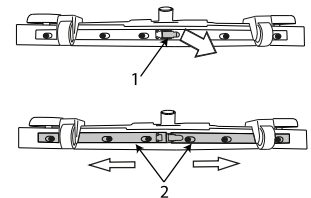

ATTACHING/REMOVING THE BRUSH

Attaching the brush:

- rest the brush on the floor in front of the machine. Raise the front of the machine by levering on the handle, then lower it onto the brush, centering it with the brush cover. Action the drive lever repeatedly until the brush engages.

Removing the brush:

- Raise the front of the machine by levering on the handle, then operate the brush lever repeatedly. After operating the lever a few times, the brush is released and falls to the ground.