

**INTRODUCTION/GENERAL
WARNINGS/SAFETY**

MACHINE IDENTIFICATION

The serial number plate (fig. 1), located at the rear of the machine, contains the following information:

- Model code;
- Model;
- Power supply voltage;
- Overall rated power;
- Serial number;
- Year of manufacture;
- Dry weight;
- Weight at maximum load;
- Maximum gradient;
- Bar code with serial number;
- Manufacturer identification.

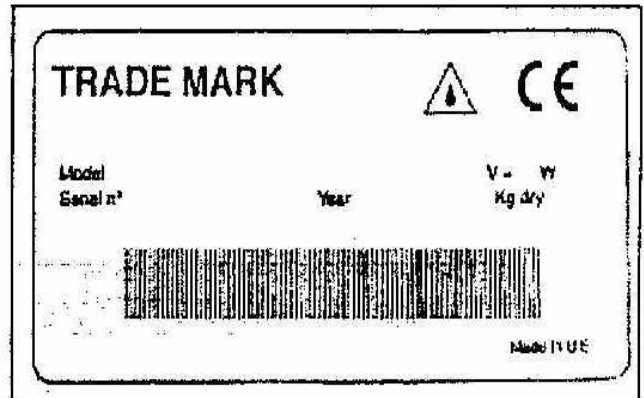

Fig. 1

TABLE OF CONTENTS

INTRODUCTION/GENERAL WARNINGS/SAFETY.....2
UNPACKING.....3
TECHNICAL SPECIFICATIONS.....4
DESCRIPTION OF COMMANDS AND CONTROL PANEL5
BATTERY5-6
BRUSH ASSEMBLY6-7
FITTING THE SQUEEGEE.....7
PRELIMINARY OPERATIONS.....8
USING THE MACHINE IN AUTOMATIC MODE.....9
DESCRIPTION OF AUTOMATIC PROGRAMS9
USING THE MACHINE IN MANUAL MODE.....10
PROGRAMMING THE FLOOR CLEANER10
MAINTENANCE.....12
SAFETY FUNCTIONS AND TROUBLESHOOTING.....14

INTRODUCTION/GENERAL WARNINGS/SAFETY

INTRODUCTION

This instruction manual is intended to serve as a guide and contains practical information on operation, adjustment and maintenance of your new machine which has been designed and built to ensure maximum performance, comfort and easy work in a wide variety of conditions. Before delivery it has been checked at the factory and by our dealer to guarantee that it is delivered in perfect condition. To maintain the machine in this condition and ensure problem-free operation, the operations specified in this manual must be performed. Before using the machine, carefully read this manual and always keep it within easy reach for further consultation. Any “left and right” indications always refer to the direction of forward movement of the machine. If you require further information on the machine, do not hesitate to contact our dealer who can provide skilled personnel, original spare parts and all necessary equipment. The machine must not be used without protection. For your safety, check that all the safety protections are closed or fitted correctly before starting the machine.

GENERAL SAFETY PRECAUTIONS

The precautions listed below must be followed carefully to prevent injury to the operator or damage to the machine.

- Carefully read the labels on the machine, do not cover them for any reason and immediately replace them if they become damaged.
- Do not mix different types of detergents: harmful gases can be produced.
- The storage temperature must be between 0°C and +55°C.
- The optimal working temperature must be between 0°C and +40°C.
- The humidity must be between 30% and 95%.
- Do not use the machine in an explosive atmosphere.
- Do not use the machine as a means of transport.
- Do not use solutions that could damage the machine.
- Avoid operation of the brushes with the machine at a standstill in order not to damage the floor.
- Do not suck up flammable liquids.
- In the event of fire use a powder extinguisher. Do not use water.
- Do not knock shelving or scaffolding where there is the danger of falling objects.
- Adapt the operating speed to the floor adhesion conditions.
- Avoid conditions of instability.
- The machine must perform the cleaning and drying operations simultaneously. Any other operations must be performed in areas that cannot be accessed by unauthorised personnel. Mark wet floor areas with appropriate notices.
- If machine operating faults are encountered, ensure that they are not due to lack of routine maintenance. Call the authorised service centre if necessary.
- When replacing parts, request original spares from a dealer and/or authorised retailer.
- For all maintenance operations, disconnect the machine from the electrical power supply.
- Do not remove protections that require the use of tools for removal.
- Do not clean the machine with direct or pressurised jets of water or with corrosive substances.
- Every 200 hours have the machine checked by an authorised service centre.
- This product is classified as RAEE type special waste and is covered by the requisites of the new environmental protection regulations (2002/96/CE RAEE). It must be disposed of separately from ordinary waste in compliance with current legislation and standards.
- The machine does not produce harmful vibrations.

INTRODUCTION/GENERAL WARNINGS/SAFETY



Special waste. Do not **dispose** of with ordinary waste.

MODIFICATIONS AND IMPROVEMENTS

Our company aims to constantly perfect its products and reserves the right to make modifications and improvements when necessary without the obligation to implement them also in machines previously sold.

SAFETY

We can all help to avoid accidents.

No accident prevention programme can be effective without the total co-operation of the persons directly responsible for machine operation.

The majority of accidents that occur in a firm, at work or during transfer are caused by failure to observe the most elementary safety rules.

A careful cautious user is the best guarantee against accidents and is more effective than any prevention programme.

During work, pay attention to persons in the vicinity, in particular children.

UNPACKING

Check that the following components have been supplied together with the machine:

Instruction manual- Warranty certificate -
Adhesive coupons for requesting spare parts -
Test sheet - EC certificate of conformity.

Check the contents of the envelope:

- 1 battery wire;
- 5 battery jumpers;
- 1 battery charger connector;
- 2 ignition keys;
- 1 general fuse.

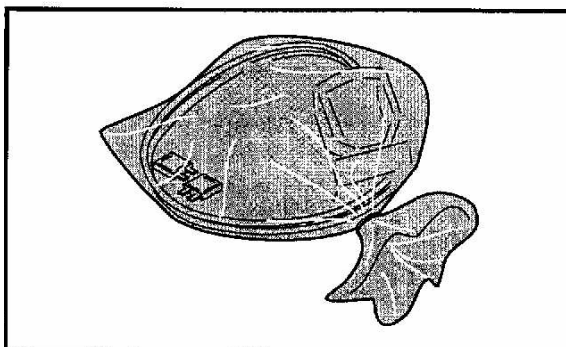
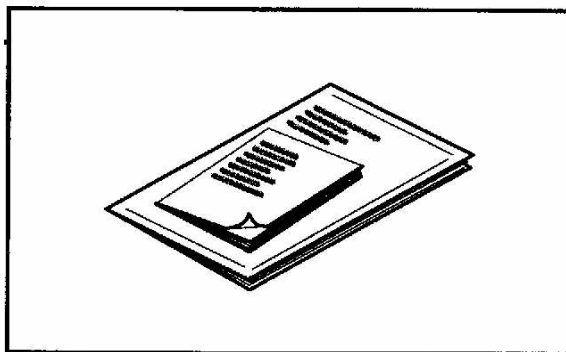

TECHNICAL SPECIFICATIONS

MODELS	700	850	950	750R
Working width (mm)	700	830	920	750
Squeegee width (mm)	830	1010	1100	1010
Automatic brush change	YES	YES	YES	NO
Brush diameter (mm)	355 X 2	435 X 2	460 X 2	150 x 750
Cylindrical brushes	-	-	-	YES
Brush rpm	200	200	200	1000
Brush motor power (W)	400 X 2	400 X 2	400 X 2	1000
Brush floor pressure (Kg)	60	90	90	50
Solution tank (L)	145	145	145	145
Recovery tank (L)	170	170	170	170
Solution min/max flow (l/min.)	1-10	1-10	1-10	1-10
Waste container capacity (L)	-	-	-	13,5
Suction motor power (W)	650-800	650-800	650-800	650-800
Suction vacuum (mmH ₂ O)	1600-2100	1600-2100	1600-2100	1600-2100
Cleaning solution automatic metering	YES	YES	YES	YES
Safety code display (Voltmeter)	YES	YES	YES	YES
Maximum gradient	16%	16%	16%	16%
Drive motor power (W)	560	560	560	560
Forward speed (Km/h)	6.5	6.5	6.5	6.5
Reverse speed (programm.)	3	3	3	3
Drive wheel diameter (mm)	250	250	250	250
Driven wheel diameter (mm)	300	300	300	300
Electrical system voltage (volt)	36	36	36	36
Length (mm)	1720	1720	1720	1720
Width (mm)				
Height (mm)	1360	1360	1360	1360
Machine weight (Kg) without batt.				
Weight with batteries				
Recommended batteries	280 Ah, 6 x 6 V	280 Ah, 6 x 6 V	280 Ah, 6 x 6 V	280 Ah, 6 x 6 V
Operating autonomy	4,5	4,5	4,5	4,5
Sound Pressure (LpA)	72 dB	72 dB	72 dB	72 dB
Sound Power	-	-	-	-
Hand vibration	0,69 m/sec ²	0,69 m/sec ²	0,69 m/sec ²	0,69 m/sec ²
Body vibration	0,28 m/sec ²	0,28 m/sec ²	0,28 m/sec ²	0,28 m/sec ²

INTRODUCTION/GENERAL WARNINGS/SAFETY

DESCRIPTION OF COMMANDS AND CONTROL PANEL

- 1=Ignition key
- 2=Forward-back selection lever
- 3=Solution flow regulation
- 4=Brush motor ON-OFF
- 5=Suction motor ON-OFF
- 6=Recovery tank overflow level indicator
- 7=No cleaning solution indicator
- 8=Brush engagement/release key (not used in mod. with roller head)
- 9=Work program selection keys and indicators
- 10=Programming key on display
- 11=Horn
- 12=Two-line alphanumeric display
- 13=Emergency stop button
- 14=Forward-reverse accelerator
- 15=Braking and parking pedal

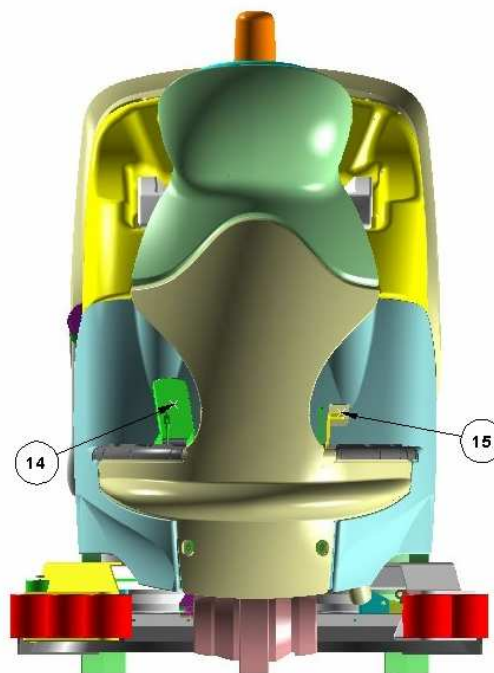
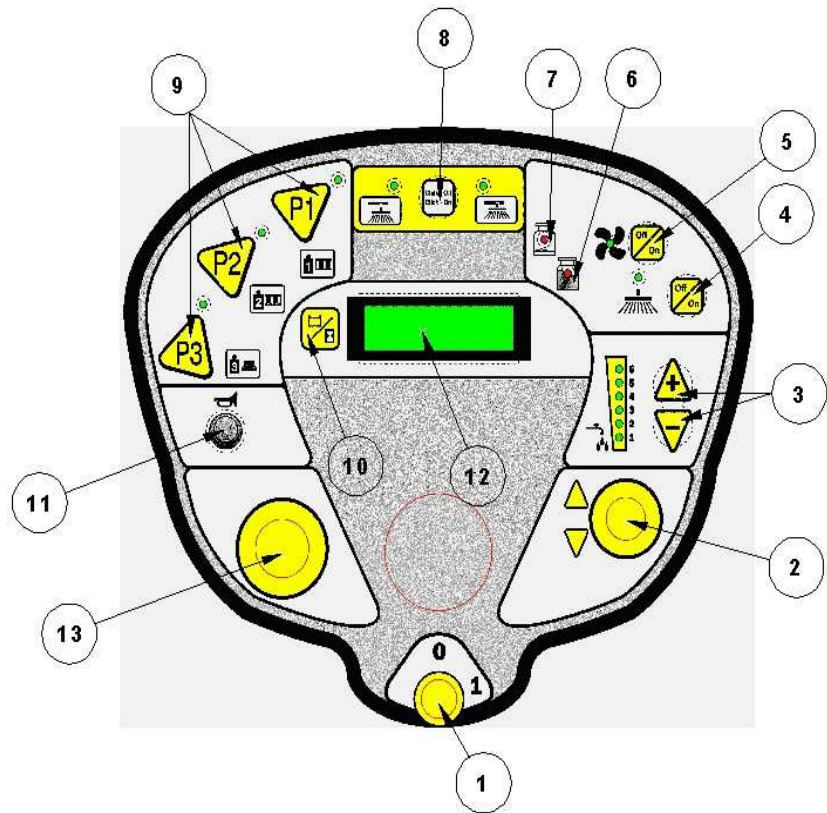

INTRODUCTION/GENERAL WARNINGS/SAFETY

BATTERY

The machine operates with a 36 Volt battery.

Three options are available, depending on the country where the machine is supplied:

- 1-Battery supplied together with the machine and fitted, filled with acid and ready for use.
- 2-Battery supplied and fitted dry (i.e. without liquid electrolyte).
- 3-Battery not supplied.

DANGER!

During installation or any type of maintenance of the batteries, the operator must be equipped with the necessary accessories (gloves, goggles, protective overalls etc.); to limit the risk of accidents, keep away from naked flames, do not short-circuit the battery poles, do not generate sparks and do not smoke.

The batteries are normally supplied filled with acid and ready for use. If the batteries are without acid, before fitting them on board they must be activated as follows:

- after removing the battery plugs, fill all the elements with sulphuric acid solution (density from 1.27 to 1.29 Kg at 25°C) making sure that the plates are fully covered;
- leave to rest for 4-5 hours, to give the air bubbles time to come to the surface and the plates time to absorb the electrolyte;
- check that the level of the liquid is still above the plates; if not, top up the level with the sulphuric acid solution;
- re-close the plugs.

A first recharge should now be performed before operating the machine: for this operation follow the directions in the relevant paragraph.

BATTERIES: installation and connection

Make sure that you fit only terminals marked with the symbol “+” on the positive poles. Do not check the battery charge by sparking. Carefully follow the instructions below as short-circuiting of the batteries can cause them to explode.

Fit the batteries on the machine using equipment suitable for their weight. The positive and negative poles have a different diameter. Referring to the arrangement of the cables schematised in the drawing on the battery case, connect the terminals to the battery poles.

Having arranged the cables as shown in the drawing, tighten the terminal fixing bolts using a spanner of suitable diameter and cover the poles with Vaseline; connect the battery wiring connector and the machine wiring connector together:
use the machine according to the instructions below.

THE BATTERY CHARGER

Never let the batteries become too low as they can be permanently damaged.

Choice of battery charger:

check that the battery charger is compatible with the batteries to be charged:

- tubular lead batteries: the battery charger must have a maximum initial current of 16 A (with DIN Wa method) or 20 A to 50 A (with DIN Wo Wa two-stage method) for every 100 Ah (5h) of the battery. Consult the manufacturer and the battery charger manual for confirmation of the choice.
- Gel batteries: use a battery charger specific for this type of battery.

INTRODUCTION/GENERAL WARNINGS/SAFETY

PREPARING THE BATTERY CHARGER

If you wish to use a battery charger not supplied with the machine, the connector sent with the machine must be fitted on it. For installation of the connector, proceed as follows:

- remove approx. 13 mm of protective sheath from the red and black cables of the battery charger;
- insert the cables in the connector ends and press with suitable crimping pliers;
- insert the cables into the connector observing the polarities (red cable + black cable -).

FITTING THE DISC BRUSHES

Raise the machine side apertures on both sides and position the brushes below the compartment ensuring that they rest against the stops to align them with the engagement unit.

Insert the key into the panel, turn clockwise and wait for the battery voltage indication to appear on the display.

Press key N°8. The machine will firstly perform a release operation (indicator A blinking), enabling the engagement operation immediately afterwards (indicator B blinking).

The machine is now ready for engagement of the brushes which can be performed by pressing key N°8 again. After pressing key 8 a second time, the indicator B will remain on, blinking until the engagement operation has been completed.

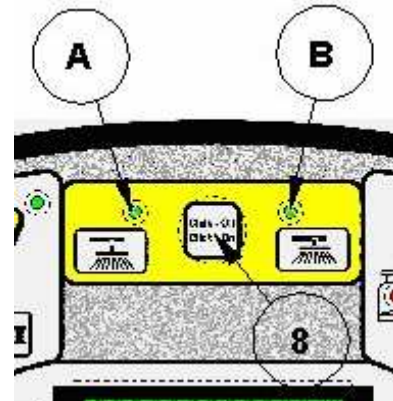
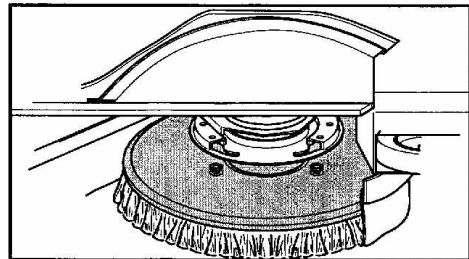
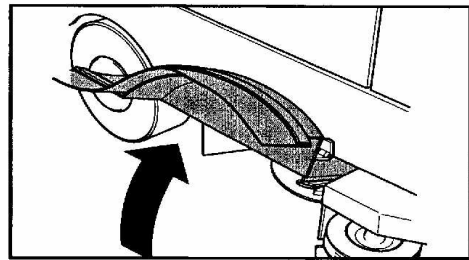

INTRODUCTION/GENERAL WARNINGS/SAFETY

FITTING THE ROLLER BRUSHES ON THE ROLLER HEAD

Open the side aperture on the head.

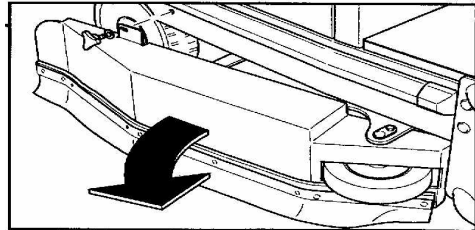

Remove the brush compartment cover (2).

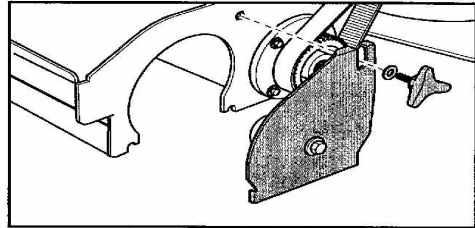

Insert the cylindrical brush into the two compartments ensuring that it mates correctly with the guide pin on the opposite side. Fit the two brush compartment covers and close the aperture.

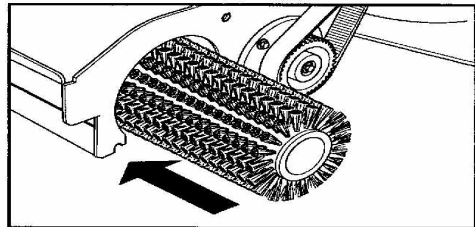

FITTING THE SQUEEGEE

Unpack the squeegee and fit it into the slots on the support as shown in the figure.

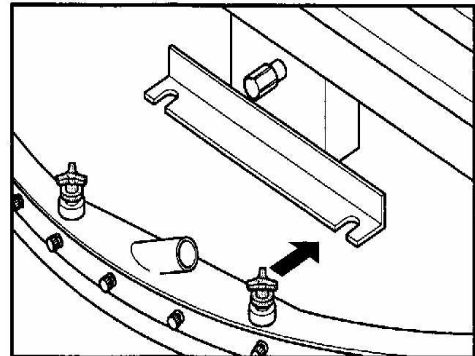

Connect the suction pipe to the squeegee. The squeegee blades scrape the film of water and detergent, thus permitting perfect drying. In the long term, the continuous friction blunts and splits the sharp edge in contact with the floor, affecting drying efficiency and thus requiring replacement of the blade. The condition of the blades should therefore be checked frequently.

Also check that the suction hole is not clogged so that all the dirty water can be removed from the floor. The squeegee is provided with two adjustments: angle and pressure, to adapt it to all surface types.

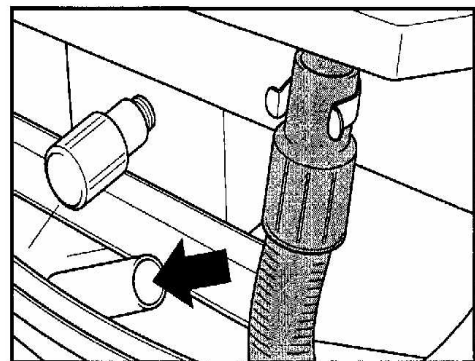

INTRODUCTION/GENERAL WARNINGS/SAFETY

PRELIMINARY OPERATIONS

Fill the tank with water and detergent solution in the quantities and proportions specified on the bottle by the manufacturer.

Caution: do not introduce solutions consisting of flammable, explosive or foamed liquids.

Insert the ignition key and turn clockwise. The display will show the type of release for 5", then the battery voltage value and the hour counter will appear.

Note: wait at least 5 seconds before switching the machine back on again after it has been switched off; if not, it will not start.

Check the battery charge via the display.

The display has three functions: voltmeter, hour counter and troubleshooting.

The voltmeter incorporates a lock function due to undervoltage which automatically disables all the functions, except for the drive, when the battery drops to a voltage of approx. 29 volts (indicating firstly battery low and then battery flat on the display). In this case proceed with battery recharging.

USING THE MACHINE IN AUTOMATIC MODE

Three different automatic work programs are available P1- P2- P3.

The work parameters of each automatic program are pre-set by the manufacturer. It is possible, if necessary, to modify these parameters either yourself (see the machine programming chapter) or by contacting your technical service centre.

Select the most suitable program from the three available; when the corresponding key is pressed, the light indicator will come on and all the functions of the pre-selected program will be activated.

Note: a new work program can be selected only after de-selecting the one previously selected. The functions performed by each of the three automatic programs are described on the following page.

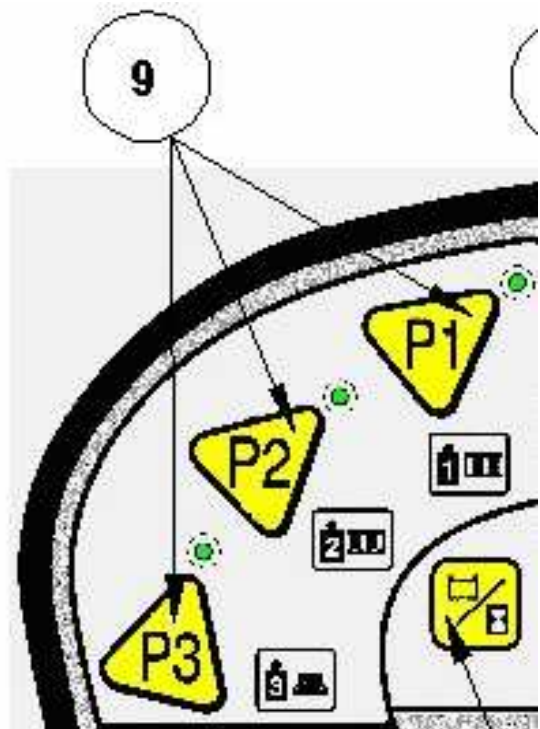

INTRODUCTION/GENERAL WARNINGS/SAFETY

DESCRIPTION OF AUTOMATIC PROGRAMS P1- P2- P3

Note: the contents of this chapter can be applied to all the models described in this manual.

P1 Light intensity cleaning program for smooth not excessively dirty floors.

P2 Medium intensity cleaning program for smooth floors with evident forms of dirt.

P3 Very intense work program for very dirty rough floors (concrete and similar).

USE

After selecting one of the three programs described above, select forward operation via the lever on the control panel (2) and press the accelerator pedal to start work.

Note: by releasing the accelerator or setting the lever to neutral, all the functions will automatically switch off within approx. 5 seconds (Auto Power-Off); in this pause condition the light indicator corresponding to the pre-selected program will blink. To re-activate the functions, simply move the machine forward, without disabling the program already selected (Auto power-ON).

A safety device is housed in the seat: when the operator stands up or abandons the machine, the drive stops in both forward and reverse direction.

Note: if reverse gear is engaged during work, the vehicle will automatically raise the squeegee and only once this has been done will the consent be given for operation. Use of reverse gear is identified by a safety buzzer (all the functions will remain active).

The machine automatically brakes when the acceleration pedal is released; if necessary the service brake can be used.

The machine is provided with an emergency stop button; when the button is pressed (red light on), the drive and all the other functions will immediately stop.

To re-activate the machine, press the button again. To resume work, one of the three automatic work programs must be re-selected.

Once you have finished work, the dirty liquid must be emptied from the tank.

Inside the dirty water recovery tank there is a floater microswitch which, once it has detected that the tank is full, automatically de-activates the suction motor. This condition is modified by switch-on of the pilot light on the dashboard.

CLEANING SOLUTION DELIVERY STOP

When the cleaning solution tank is low an intermittent acoustic signal will be emitted (3 times) and “water low” will appear on the display. After approximately one minute, the intermittent acoustic signal will resume and “no water” will appear on the display; at the same time the brush motors and water delivery will stop.

Fill the tank to continue work after switching the machine off to re-set the alarm signals.

INTRODUCTION/GENERAL WARNINGS/SAFETY

USING THE MACHINE IN MANUAL MODE

In order to work in manual mode it is not necessary to select any of the automatic work programs (P1, P2, P3); the required value can be set using the buttons as in the attached figure.

Key N°5 SUCTION UNIT ON-OFF
Key N°4 BRUSH ON-OFF
Key N°3 WATER ON-OFF

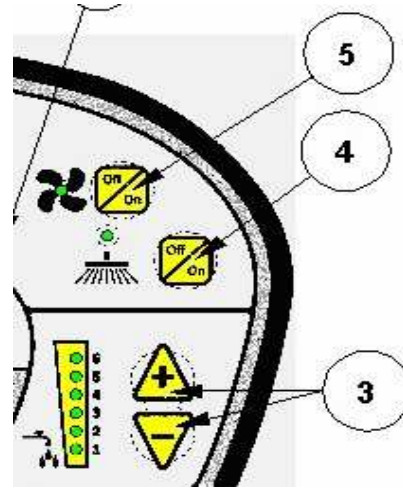

PROGRAMMING THE FLOOR CLEANER

Enter USER PROGRAMMING by keeping the display button pressed for 5" during display of the battery voltage without any load.

The following can be programmed in the order given below:

- 1. LANGUAGE:** can be selected via the water buttons – and +. When the display button is pressed briefly, the setting is stored and you go on to the next page.
- 2. P1 Brush Enable:** ON or OFF. The parameter can be changed via the usual buttons – and +. When the display button is pressed briefly, the setting is stored and you go on to the next page.
- 3. P1 Brush working pressure:** from 010 to 100. The parameter can be reduced by pressing the button “-“ and increased by pressing the button “+”. When the display button is pressed briefly, the setting is stored and you go on to the next page.
- 4. P1 Suction unit enable:** ON – OFF. The parameter can be changed via the buttons “-“ and “+” . When the display button is pressed briefly, the setting is stored and you go on to the next page.
- 5. P1 Water delivery:** the parameter can be set on the following values:
 - OFF:** when the program is recalled, water delivery is not activated.
 - LEV.1:** pump active with work cycle 18%
 - LEV.2:** pump active with work cycle 36%
 - LEV3.:** pump active with work cycle 45%
 - LEV.4:** pump active with work cycle 60%
 - LEV.5:** pump active with work cycle 75%

INTRODUCTION/GENERAL WARNINGS/SAFETY

LEV.6: pump active with work cycle 100%

Auto: pump active according to drive work cycle

Up to 16% of speed, pump active 18%

Up to 32% of speed, pump active 36%

Up to 50% of speed, pump active 45%

Up to 65% of speed, pump active 60%

Up to 80% of speed, pump active 75%

Over 80% of speed, pump active 100%

The parameter can be changed via the buttons “-“ and “+”. When the display button is pressed briefly, the setting is stored and you go on to the next page.

6.P1: Work speed: maximum drive speed. The parameter can be varied between 010 and 100 . The parameter can be reduced by pressing the button “-“ and increased by pressing the button “+”. When the display button is pressed briefly, the setting is stored and you go on to the next page.

7.P1: POWER OFF enable: ON or OFF. The parameter can be changed via the buttons “-“ and “+”. When the display button is pressed briefly, the setting is stored and you go on to the next page.

For P2 and P3 the same procedure as the one above is used.

MAINTENANCE

Battery check and recharging

Periodically check the level of the electrolyte inside the battery. The battery compartment is below the operator’s seat; raise the battery compartment cover and open the cell plugs: when necessary fill the cells using distilled water; sulphuric acid solution must be used only the first time the battery is activated dry.

Exercise extreme caution: the battery liquid is corrosive; if it comes into contact with the skin or eyes, wash with plenty of water and seek medical advice.

After filling, close the cells with the plugs and clean the upper surface.

When necessary, recharge the battery following the instructions below:

- Recharging must be performed in a well-ventilated area
- Switch the machine off via the main key
- Open the battery compartment and disconnect the machine battery connector; open all the covers of the 18 battery cells (or elements)
- Connect the battery connector to the battery charger
- Connect the battery charger to the mains (the mains voltage and frequency must be equal to the corresponding values applicable to the battery charger)

**INTRODUCTION/GENERAL
WARNINGS/SAFETY**

MAINTENANCE

At the end of the recharge, disconnect the battery from the battery charger and reconnect it to the machine.

Close all the 18 battery cells and clean the upper surface of the battery to remove all remains of acid.

NOTE: in any case, follow the directions provided in the battery instruction manual.

EMPTYING THE WASTE BOX

In the model with roller head, periodically empty the waste box at the rear of the roller head.

Proceed as follows: rotate it towards the rear of the machine to disengage it from the head and slide it out crosswise to the machine.

Empty the waste and clean with a jet of water.

Reposition it, repeating the above steps in reverse order.

ROUTINE MAINTENANCE SUMMARY TABLE

Caution: operation to be performed with the machine switched off and the key removed.

All routine or extraordinary maintenance operations must be performed by qualified personnel, or at authorised service centres.

NOTE: the battery life depends on regular routine maintenance (electrolyte density and level check).

If the machine is not used for a long period (for example 4 to 6 weeks) the battery must be recharged in any case to ensure that its voltage never drops below the threshold of 29 volts.

Batteries that are not used will run flat.

CHECK	ON DELIVERY	WHEN NECESSARY	EVERY 30h	EVERY 100h	EVERY 500h
Battery liquid level and voltage	●		●		
Check brushes of all electric motors and replace if necessary					●
Brake adjustment				●	
Tightening of nuts and screws				●	
Wear on the brushes				●	
Filter cleaning			●		
Waste box cleaning		●			
Grease steering chain				●	

INTRODUCTION/GENERAL WARNINGS/SAFETY

SAFETY FUNCTIONS AND TROUBLESHOOTING

The machine is provided with some safety functions.

Cut-in of the safety functions is shown via descriptions on the display (see table below) that facilitate identification of the faults or possible failures.

ref.	DISPLAY ERROR CODE	BRUSH	VACUUM	TRACTION	ERROR SOURCE	CAUSE	REMEDY
1	TRACTION PROBLEM	OFF	OFF	OFF	main board	a- main board failure	a- replace the main board MECE00265 ;if control panel release is < 1.26, replace the control panel MEQE00050 too
2	MOTOR TEMPERATURE PAUSE	OFF	OFF	OFF	traction motor temperature sensor > 95°C	a- machine worked too much in a ramp b- the motor current consumption c- the motor thermal sensor	a- wait ≈ 30' that the traction wheel temperature go down b- if current is > 18A replace the tration motor RTRT00250 c- if at ambient temperature is open, replace it, METK00026
3	TRACTION TEMPERATURE PAUSE	OFF	OFF	OFF	main board temperature sensor > 85°C	a- machine worked too much in a ramp b- the motor current consumption	a- wait ≈ 30' that the main board temperature go down b- if current is > 18A replace the tration motor RTRT00250 c- replace the main card MECE00265 and the control panel MEQE00050
4	KEY ACCELERATOR SEQUENCE	OFF	OFF	OFF	accelerator pedal microswitch and potentiometr	a- pedal in pushed before key turning ON	a- release the pedal
5	TRACTION POTENTIOMETER	OFF	OFF	OFF	accelerator pedal potentiometer	a- the plug under the pedal bad connected b- the potentimeter is broken	a- check and tight the plug b- replace the potentiometer (see service bulletin 20060047)
6	BRUSH TEMPERATURE PAUSE	OFF	ON	ON	main board temperature sensor > 85°C	a- machine worked too much at high pressure b- the working program is to heavy for the floor c- electronics faulty	a- wait ≈ 30' that the main board temperature go down b- pass from P3 to P2 or P1 (if already P1 use the programming instruction to check the pressure value setted) c- replace the main card MECE00265 and the control panel MEQE00050
7	BATTERY LOW	ON	ON	ON	battery	a- battery voltage is ≤ 31.5V	a- expect to charge the battery

INTRODUCTION/GENERAL WARNINGS/SAFETY

8	BATTERY FLAT	OFF	OFF	ON	battery	a- battery voltage is $\leq 29V$	a- charge the battery
9	BATTERIA ESAURITA	OFF	OFF	OFF	battery	a- battery voltage is $\leq 27V$	a- check the battery levels and charge the battery
10	BRUSHES WORN	ON	ON	ON	brush head low position microswitch inside the actuator	a- brushes are worn b- the floor is very smooth and the electronic doesn't read enough current consumption	a- replace the brushes b- pass from P3 to P2 or P1: if already P1, use the programming instruction to reduce the brushes pressure
11	PARKING BRAKE	ON	ON	ON	microswitch in the parking brake pedal	a- parking brake is engage b- brake microswitch is wrong fixed c- brake microswitch is broken	a- unlock the brake by pushing the L shape lever near the pedal b- check and eventually adjust the microswitch position c- replace the microswitch
12	RECOV.TANK LEVEL	ON	OFF	ON	level sensor inside the recovery tank	a- recovery tank level sensor is engage by the water level b- recovery tank level sensor is blocked in upper position	a- empty the recovery tank and reset the machine (key OFF/ON) b- check the sensor and eventually replace it (code MECI00516)
13	WATER RESERVE	ON	ON	ON	level sensor inside the solution tank MECI00400	a- solution tank level sensor is engage by the low water level b- solution tank level sensor is blocked in lower position	a- expect to empty the recovery tank and fill the solution tank b- check the sensor and eventually replace it (code MECI00516)
14	NO WATER	OFF	OFF	ON	level sensor inside the solution tank MECI00400	a- is more than 5 minutes that the solution tank level sensor is engage by the low water level b- is more than 5 minutes that the solution tank level sensor is blocked in lower position	a- empty the recovery tank and fill the solution tank and reset the machine (key OFF/ON) b- check the sensor and eventually replace it (code MECI00516)
15	POTENTIOMETER ALIGNMENT	OFF	OFF	OFF	accelerator pedal potentiometer	a- replacement of the potentiometer b- wrong ohm value in zero position	a- use the programming instruction to align the new potentiometer b- set to 0Ω in zero position and follow the remedy "a" to align it