

This guide is intended for quick consultation only and does not replace the user and maintenance manual. Before using the machine, read the user and maintenance manual contained in the machine's packaging thoroughly and strictly follow all the instructions.

PREPARATION & OPERATION

1

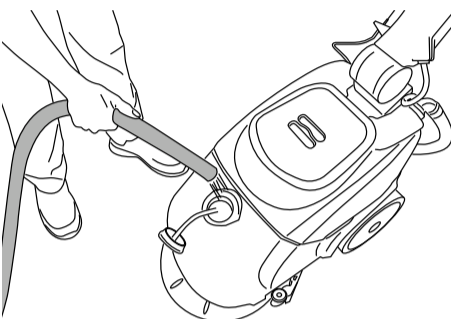

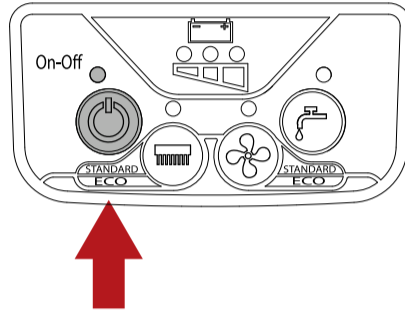

2

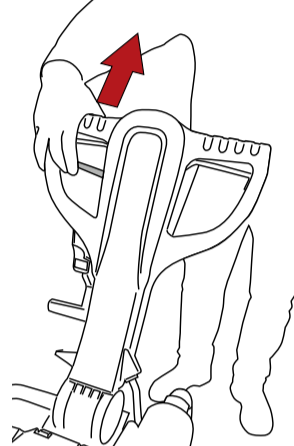

3









5

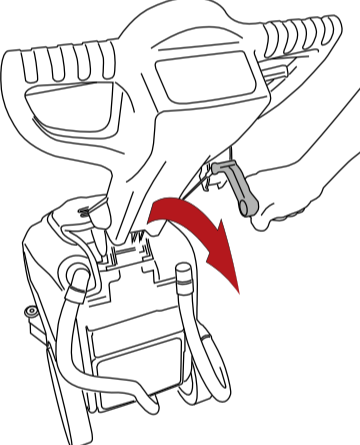

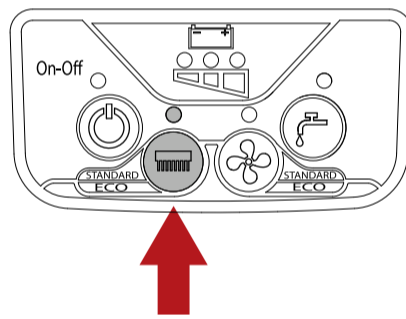

6

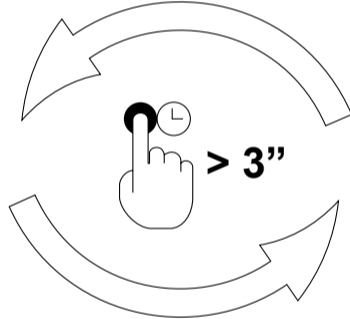

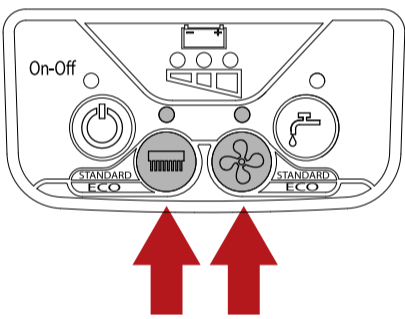







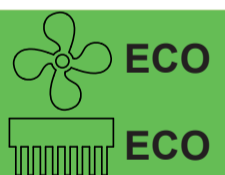

7

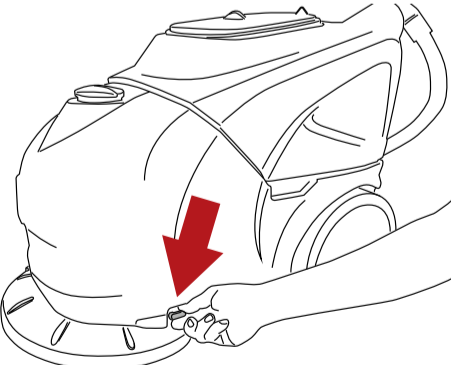

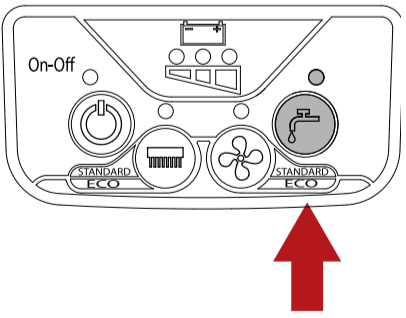

8

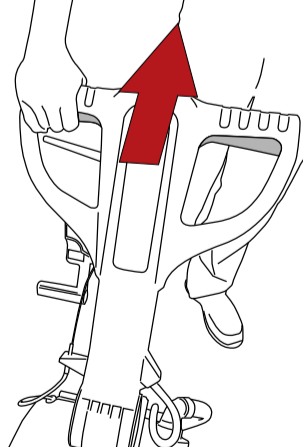

9







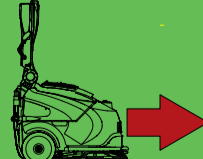

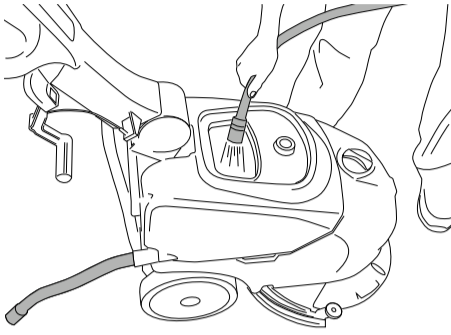
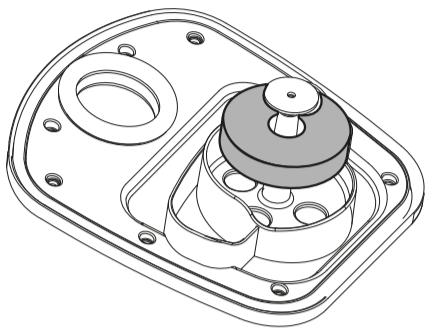
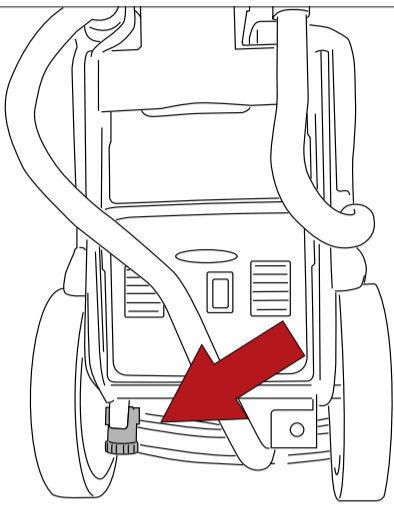
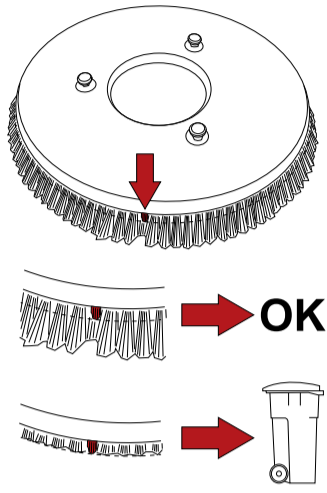

DAILY MAINTENANCE

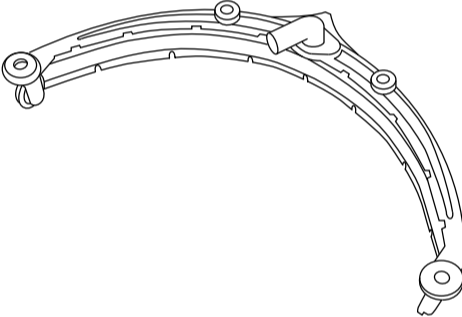
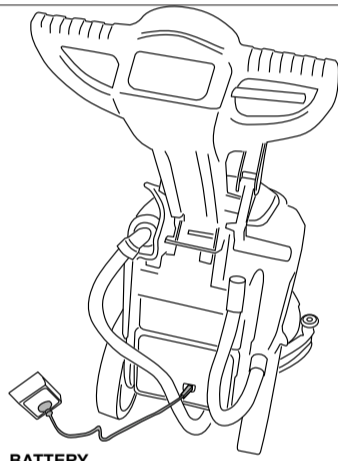
			
<p>Clean the dirty water tank.</p>	<p>Check the dirty water tank float is undamaged and clean and moves freely on the pin.</p>	<p>Check that the detergent outlet filter is clean.</p>	<p>Check that the brush is clean. Replace if necessary.</p>

	 <p>BATTERY CHARGER ON BOARD</p>
<p>Check that the squeegee is clean and the blades are not worn.</p>	

REPLACING THE SQUEEGEE BLADES

- unscrew the nuts fixing the blade retainers;
- remove the two blade retainers;
- remove the blade;
- put the same blade back, reversing the edge in contact with the floor until all four edges are worn, or replace with a new one;
- put the two blade retainers back on the squeegee and screw up the nuts again;

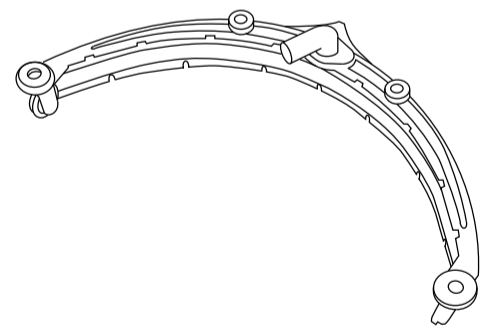

ATTACHING/REMOVING THE BRUSH

Attaching the brush:

- rest the brush on the floor in front of the machine. Raise the front of the machine by levering on the handle, then lower it onto the brush, centring it with the brush cover. Action the drive lever repeatedly until the brush engages..

Removing the brush:

- Raise the front of the machine by levering on the handle, then operate the brush lever repeatedly. After operating the lever a few times, the brush is released and falls to the ground.