



# IPC Eagle

## **OPERATIONS MANUAL & PARTS LIST**

BP6, BP10  
Backpack Vac



## **BEFORE OPERATING THE MACHINE**

Read the manual carefully and completely before attempting to operate the unit. This manual has important information for the use and safe operation of the machine. Keep this manual handy at all times. This machine will assure years of satisfactory service if operated and maintained according to recommendations in this manual. If additional information is needed, please contact your local distributor or write to:

**IPC Eagle  
3650 Dodd Rd.  
Eagan, MN 55123**

## **INSPECTION**

Carefully unpack and inspect your commercial backpack vacuum for shipping damage. Each unit is tested and thoroughly inspected before shipping. For instructions regarding shipping damage, contact IPC Eagle immediately. All returns must have a Return Authorization Number.



## **WARNING**

- Do not leave backpack vacuum plugged in when not in use. Unplug the unit from the wall outlet before serving.
- Do not leave outdoors or on wet surfaces.
- Do not try to vacuum any liquid with this unit. This vacuum is designed for dry vacuuming only.
- Use only as described in this manual. Use only the manufacture's recommended attachments and replacement parts.
- To prevent electrical damage, use the recommended 50 ft/ 16 gauge extension cord provided. If you need to use a 100 ft. extension cord, it must be 14 gauge or greater. DO NOT use extension cords greater than 100 ft. with this unit.
- Do not use a damaged power cord or plug. If the unit is not operating as intended, if the unit has been dropped, damaged, left outdoors, or exposed to water, return the unit to an authorized IPC Eagle representative for an inspection.
- Do not carry the unit by the power cord or use the power cord as a handle. Do not close a door on the power cord or wrap around sharp edges or corners. Do not run over the power cord. Keep the power cord away from heated surfaces.
- Do not pull on the power cord to unplug the unit. Grasp plug at the wall outlet.
- Do not handle with wet hands.
- Do not put any objects into openings. Keep hair, loose clothing, fingers, and all parts of the body away from openings and moving parts. Long hair should not hang over or near the unit.
- Do not vacuum flammable/ combustible materials or anything that is burning or smoking such as cigarettes, matches or hot ashes.
- Empty the filter bag after every use and before storage. Some types of dust and debris may combust.
- Turn off the unit before unplugging.
- Connect to a properly grounded outlet only.

**FAILURE TO COMPLY WITH THE ABOVE WARNING INSTRUCTIONS  
WILL VOID YOUR WARRANTY**

## MOTOR

AMETEK LAMB electric thru-flow vacuum motors must never be used in applications in which wet or moist conditions are involved. Such motors are designed to permit the vacuumed air to pass over the electrical wiring to cool it. Therefore, any liquid (including water), dry chemical or other foreign substance which would come in contact with electrical conductors could cause combustion (depending on volatility) or electrical shock. Failure to observe these precautions could result in property damage and severe personal injury.

## ELECTRICAL

This model is available in 120 Vac/ 60Hz only. Severe changes in voltage, high or low, can cause damage to the motor and premature motor failure. Model number and specifications can be obtained by calling an IPC Eagle representative.

## GROUNDING INSTRUCTIONS

### *THIS VACUUM MUST BE GROUNDED*

If the unit should malfunction or stop operating, grounding provides a path of least resistance for electrical current, therefore reducing the risk of electrical shock. This unit is equipped with a power cord that has an equipment grounding conductor and grounding plug. The plug must be inserted into an appropriate outlet that is properly installed and grounded in accordance with all local codes and ordinances. Cutting off the ground wire or using an extension cord that is not equipped with a grounding plug will void the warranty on this unit and IPC Eagle will not accept liabilities associated with this unit.

Improper connection of the equipment grounding connector can result in a risk of electrical shock. Check with a qualified electrician or service person if you are in doubt that the outlet is properly grounded. Do not modify the grounding plug on the vacuum in any way.

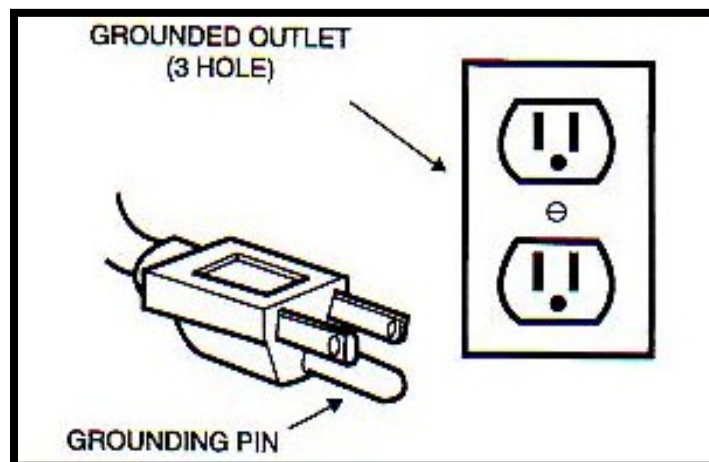

## PREPARING THE BACKPACK FOR OPERATION

1. Remove the top cap and pull out the cloth filter. Verify that the dome filter has not shifted during shipping. Install a micro filter inside the cloth filter. At the beginning of each shift, the filters should be checked. Empty or replace as necessary.

*NOTE: Never use a Micro Filter without the cloth filter in place.*

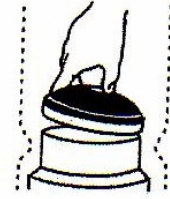

2. Adjust the cap back into place and insert the vacuum hose into the cap opening.



3. Place the aluminum wand into the vacuum hose and twist to secure. Verify that both ends of the vacuum hose are tightly secured.



4. Loosen the shoulder straps and the waist belt. In an open area, lift the backpack and place arms through the shoulder straps.



5. Fasten the waist belt on the backpack, making sure the weight is resting comfortably on your hips.

*NOTE: The back plate may be adjusted up or down by removing the screws that attach the backpack to the back plate.*

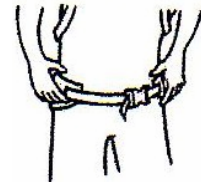

6. Place extension cord between the waist belt and your body to signal when you have run out of cord while vacuuming.

*NOTE: Verify that the power cord is in good working order before turning on the unit.*

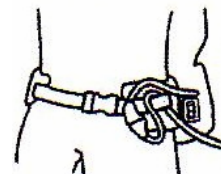

7. Loosen the plastic nut located at the end of the wand to insert the attachment tools and tighten the plastic nut.

*NOTE: Never remove the plastic nut and verify the copper rings stays in place when attaching the tools.*

## OPERATING SECTION

### Electrical Power Cord Care

Never stretch the power cord tightly between the backpack and the electrical outlet.

*NOTE: A power cord that is stretched or pulled may not function properly and can create a dangerous condition.*

After vacuuming, unplug the extension cord at both ends and wind the cord up loosely. Don not wind the extension cord up by wrapping the cord around your hand and elbow.



### Proper Storage

When the backpack is not in use, store the unit in a dry place.

### Proper Vacuuming Motion for Large Areas

Begin with the wand placed parallel to your body.

Pull the top portion of the wand inward towards your waist and twist at the waist while walking backward or forwards (using a side-by-side motion).

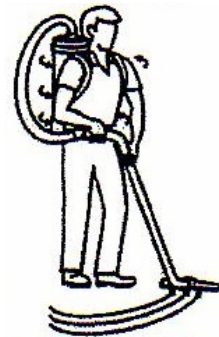

### Ergonomics

- The waist of the vacuum should be carried on the operator's hips and be evenly distributed.
- The padded waist belt and shoulder straps are adjustable for a custom fit.
- The backpacks have a ventilated back plate to keep the operator cool.
- The ON/OFF switch is conveniently placed for easy access on the waist belt of the backpack.
- Use the proper attachments for the job. IPC Eagle has attachments to perform most jobs without requiring the operator to bend over or get into difficult positions.

### Caring for the Backpack.

- Every time you have finished vacuuming, clean the cloth and/ or micro filter.
- Each week, rinse, air dry and return the foam filter diffuser to the bottom of the backpack vacuum located below the motor.
- After each shift, wipe the inside and outside of the backpack with a household cleaning agent.

# PREVENTATIVE MAINTENANCE SECTION



## WARNING:

- To avoid risk of electrical shock, personal injury or death; disconnect power before servicing.
- The following information is for use by a qualified service personnel only and is to provide guidance for troubleshooting and maintenance.
- Check the condition of all electrical power cords before each use.
- Service the backpack every six months by a qualified authorized service center to check the carbon brushes on the motor and replace any brush worn down to ½” in length.
- Do not lubricate the motor; motor is equipped with sealed bearings.

## Filter Maintenance

1. Check the Micro Filter each and every time the unit is operated and finished operating.

*NOTE: A clogged or dirty filter will restrict airflow, which could result in reduction of suction and overheating.*

While vacuuming throughout a structure, stop every two hours or as needed to clean the micro filter. Replace the micro filter when necessary.

*NOTE: Lift both the micro filter and the cloth filter from the unit at the same time. This will prevent the micro filter from being damaged especially if the micro filter is full.*

Once a month or more often if necessary, wash the cloth filter by hand or by machine and line dry. DO NOT PLACE IN DRYER.

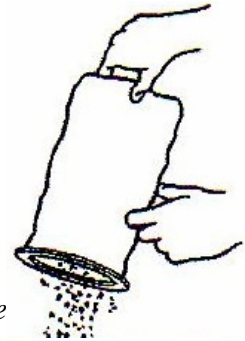

2. Once a week or more often if necessary, clean the dome filter located inside the vacuum underneath the micro filter and cloth filter.



3. Each week, rinse, air dry and return the foam filter diffuser to the bottom of the backpack vacuum located below the motor.



# TROUBLESHOOTING

## **UNIT DOES NOT OPERATE**

### **POSSIBLE CAUSE**

*Unit is not plugged into the extension cord.*

*Unit is not plugged into the electrical outlet.*

*Power switch not turned on?*

### **SOLUTION**

Plug into the 50ft extension cord provided.

Plug into an electrical outlet.

If no, plug the unit into an electrical outlet.  
If yes, verify electrical outlet has power.  
Circuit breaker may have tripped or blown a fuse.

---

## **WARMER THAN NORMAL EXHAUST**

### **POSSIBLE CAUSE**

*Dirty filters.*

### **SOLUTION**

Clean all filters in the unit

---

## **WARM POWER CORD PIGTAIL**

### **POSSIBLE CAUSE**

*Extension cord is too long and/or wrong gauge.*

### **SOLUTION**

Verify that extension cord does not exceed 50 ft in length and the correct gauge or wiring is used.

---

## **LOSE OF SUCTION**

### **POSSIBLE CAUSE**

*Cap not on tight.*

*Dirty filters.*

*Loose hose cuffs.*

*Holes or cuts in the vacuum hose.*

### **SOLUTION**

Attach cap properly.

Clean all filters in the unit.

Tighten hose cuffs.

Replace vacuum hose; call for service

---



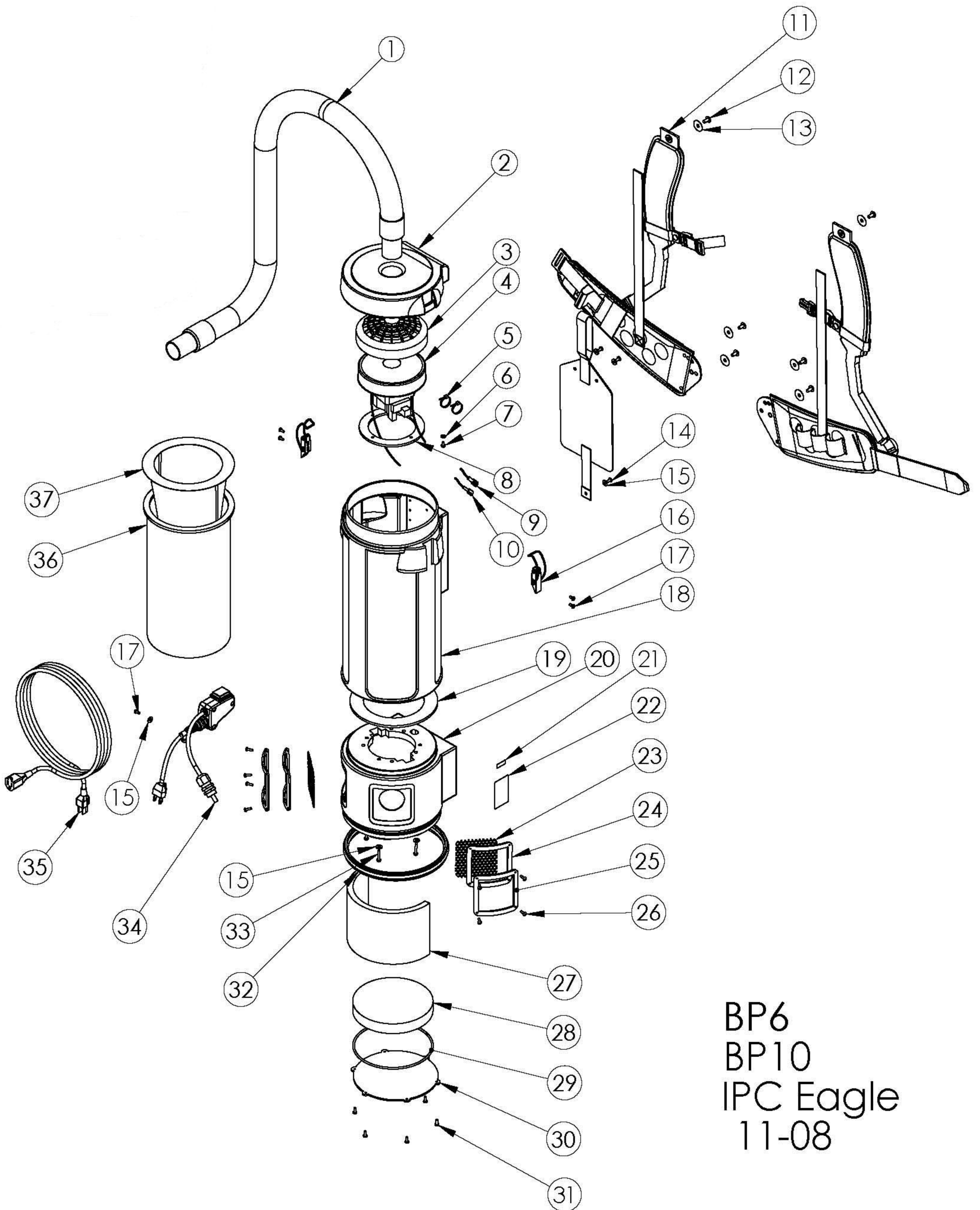

BP6  
 BP10  
 IPC Eagle  
 11-08



## BP6 and BP10

ITEM #	BP10	BP6	DESCRIPTION	QTY
1	J12035		Hose, 4" X 1.5 in	1
2	F13054	F12909	Lid, 10 qt	1
3	K12019		Dome Filter Assembly	1
4	G13145		Vacuum, 5.7, Single Stage	1
5	B00190		Nylon Tie, 4 in	2
6	C00256		Star Washer	1
7	C00284		Screw, 10-32 X .375 Ground	1
8	E12065		Gasket, Motor, Ametek	1
9	B00178		Spade Connector, Male	1
10	B00177		Spade Connector, Female	1
11	L12011		Harness, Atlas Backpack	1
12	C12040		Screw, 1-4 20 X .5 in PH	6
13	C12039		Washer, 1-4 X 1, SS	6
14	C11529		Screw, 10-32 X .375 in	3
15	C03251		Washer	8
16	D12020		Latch, Black	2
17	C12096		Screw, 8-32 X .375 in RH Mach.	5
18	F13055	F12910	Tank, 10 qt/ 6qt	1
19	E12050	E12051	Seal, Upper & Lower Tank	1
20	F13056	F12911	Base, 10 qt/ 6 qt	1
21	H11839		Label, Patent Pending	1
22	H00565-5		Label, Serial Number, Standard	1
23	D12026		Grille, Exhaust, Aluminum	2
24	E12024		Gasket, Frame, Exhaust	2
25	F12025		Frame, Exhaust	2
26	C00293		#8 X .5 in Pan Black	8
27	E12916		Foam, 5.25 X 14 X .5 in	1
28	E12028	E12044	Foam, 6.75 in. Dia X 1 in	1
29	E11998	E12047	O-Ring, Backpack	1
30	F12043	F12048	Plate, .125 in ABS, 10 qt/ 6qt	1
31	C02288		Screw, #8 X .5 in, Black Pan	6
32	E12031	E12041	Bumper Ring, 10 qt/ 6 qt	1
33	C12073		Screw, #8 X 1.125 in, Washer Hex	4
34	B12018		Cord-Switch Assembly	1
35	B11944		Power Cord, 16-3 X 50'	1
36	L12010	L12009	Filter Bag, Cloth, 10 qt/ 6 qt	1
37	L12006-1	L12004-1	Synth Bag, Individ., 10 qt/ 6qt	1

# NOTES